

***User's Manual***  
***English***

The **CE** symbol on our products signifies that they have been certified according to the EMC directive 89/336/EEC, the Telecommunications directive 91/263/EEC, and the Low Voltage directive 73/23/EEC when applicable. The products fulfil the requirements according to the following standards:

**Cellular Phones and Accessories in Combination:**

*ETS 300 342-1 EMC for European digital cellular telecommunications.*

**Accessories Without Direct Connection to a Cellular Phone:**

*EN 50081 Electromagnetic compatibility, Generic Emission Standard, and  
EN 50082 Electromagnetic compatibility, Generic Immunity Standard.*

## **This manual describes Ericsson GF768**

**First edition** (March 1997)

This manual is published by **Ericsson Mobile Communications AB**, without any warranty. Improvements and changes to this manual necessitated by typographical errors, inaccuracies of current information, or improvements to programs and/or equipment, may be made by **Ericsson Mobile Communications AB** at any time and without notice. Such changes will, however, be incorporated into new editions of this manual.

All rights reserved.

© **Ericsson Mobile Communications AB**, 1997.

Publication number: **LZT 126 1343/2 R1A**

Printed in Sweden

INNOVATRON PATENTS

# Guidelines for Safe and Efficient Use

## Important: Read this information before using your portable phone

### General

Since its introduction in the mid 1980s the portable phone is one of the most exciting and innovative products ever developed. With it, you can stay in contact with your office, your home, emergency services, and others.

Your telephone is a radio transmitter and receiver. When it is ON it receives and also sends out radio frequency (RF) energy. Depending upon the type of mobile phone you have purchased, it operates in different frequency ranges and employs commonly used modulation techniques. When you use your phone, the system handling your call controls the power level at which your phone transmits.

For the safe and efficient operation of your phone, observe these guidelines.

### Exposure to radio frequency energy

The International Commission on Non-Ionizing Radiation Protection (ICNIRP), sponsored by the World Health Organization (WHO), published a statement in 1996 which sets limits for exposure to RF fields from handheld mobile phone. According to this statement, which is based on the available body of research, there is no evidence that mobile terminals meeting the recommended limits can cause any adverse health effects. All Ericsson telephones conform to the ICNIRP recommendations, and international exposure standards, such as:

- CENELEC European Pre-standard ENV50166-2

LZT 126 1343/2 R1A

- ANSI/IEEE C95.1-1992 (USA, Asia-Pacific)

If you want to limit RF exposure even further, you may choose to control the duration of your calls and operate your phone in the most power efficient manner.

### Efficient phone operation

How to use your phone for optimum performance with minimum power consumption:

- Hold the phone as you would any other telephone. While speaking directly into the mouthpiece, angle the antenna in a direction up and over your shoulder. If the antenna is extendable, it should be extended during a call.
- **Do not** hold the antenna when the phone is **IN USE**. Holding the antenna affects call quality, may cause the phone to operate at a higher power level than needed and shorten talk and standby times.

### Antenna care and replacement

Do not use the phone with a damaged antenna. Replace a damaged antenna immediately. Consult your manual to see if you may change the antenna yourself. If so, use only an Ericsson approved antenna. Otherwise, take your phone to a qualified service centre for repair.

Use only the designated Ericsson antenna. Unauthorized antennas, modifications, or attachments could damage the phone and may violate the appropriate regulations.

Do not use an antenna designed for any other type of portable telephone than the telephone you have purchased.

### Driving

Check the laws and regulations on the use of telephones in the areas where you drive. Always obey them. Also, when using your phone while driving, please:

- Give full attention to driving.
- Use hands-free operation, if available.
- Pull off the road and park before making or answering a call if driving conditions so require.

RF energy may affect some electronic systems in motor vehicles. In addition, some vehicle manufacturers forbid the use of mobile phones in their vehicles. Check with your vehicle manufacturer's representative to be sure your phone will not affect the electronic systems of your vehicle.

### Electronic devices

Most modern electronic equipment, for example, equipment in hospitals and cars, is shielded from RF energy. However, RF energy from telephones may affect some electronic equipment.

Turn your phone OFF in health care facilities when regulations posted in the areas instruct you to do so. Always request permission before using your phone near medical equipment.

Mobile telephones may affect the operation of some implanted cardiac pacemakers, equipment for people with hearing impairments and other medically implanted equipment. Pacemaker patients should be aware that the use of a mobile phone very close to a pacemaker may cause the device to malfunction. Avoid placing the phone over the pacemaker, i.e. in your breast pocket. When using the phone, place it at your ear opposite the pacemaker. If a distance of 15cm. is kept between the phone and the pacemaker, the risk of interference is limited. Contact your cardiologist for more information.

### **Aircraft**

Turn your phone OFF before boarding any aircraft.

- Use it on the ground only with crew permission
- Turn off your phone before the aircraft leaves the ground. Do not use it in the air.

To prevent possible interference with aircraft systems, safety regulations require you to have permission from a crew member to use your phone while the plane is on the ground. To prevent interference with communication systems, you must not use your phone while the plane is in the air.

### **Power Supply**

- Connect AC (Power supply) only to designated power sources as marked on the product.
- To reduce risk of damage to electric cord, remove from outlet by holding onto AC adapter rather than cord.
- Make sure the cord is located so that it will not be stepped on, tripped over or otherwise subjected to damage or stress.

- To reduce risk of electric shock, unplug unit from power source before attempting any cleaning, then use soft cloth dampened on with water.

### **Children**

Do not allow children to play with your phone. It is not a toy. Children could hurt themselves or others (by poking themselves or others in the eye with the antenna for example). Children could also damage the phone or make calls that increase your telephone bills.

### **Blasting areas**

To avoid interfering with blasting operations, turn your unit OFF when in a “blasting area” or in areas posted “turn off two-way radio”. Construction crews often use remote control RF devices to set off explosives.

### **Potentially explosive atmospheres**

Turn your phone OFF when in any area with a potentially explosive atmosphere. It is rare, but your phone or its accessories could generate sparks. Sparks in such areas could cause an explosion or fire resulting in bodily injury or even death.

Areas with a potentially explosive atmosphere are often, but not always, clearly marked. They include fuelling areas, such as gas stations, below deck on boats, fuel or chemical transfer or storage facilities, and areas where the air contains chemicals or particles, such as grain, dust, or metal powders.

Do not transport or store flammable gas, liquid, or explosives in the compartment of your vehicle which contains your phone and accessories.

### **Product care**

- **Do Not** expose product to water or moisture. Example: bathtub, laundry sink, wet/damp basement, swimming pools, etc.
- **Do Not** expose product to extreme temperatures such as found near a hot radiator or stove, or in a car parked in the sun.
- **Do not** expose product to extreme cold temperatures such as a car parked outdoors in winter.
- **Do Not** expose product to lit candles, cigarettes, cigars, open flames, etc.
- **Use only Ericsson Original accessories.** Failure to do so may result in loss of performance, fire, electric shock, or injury, and will void the warranty.
- **Do Not** attempt to disassemble the product. Doing so will void warranty. This product does not contain consumer serviceable components. Service should only be performed by Authorized Service Centres.

# Table of Contents

## Guidelines for Safe and Efficient Use

### Assembly Instructions

- Assemble and Charge – Four Steps
- 1. Inserting SIM Card
- 2. Attaching Battery
- 3. Connecting Charger to Phone
- 4. Connecting Charger to Mains
- About the Charging Function
- About the Battery and the SIM Card

### Turning On the Phone and General Information

- Turning On the Phone
- About the Display
- Learning about Your Phone

### Making and Receiving Calls

- Making a Call
- Ending a Call
- Making an International Call
- Making an Emergency Call
- Retry Function
- Receiving a Call
- Answering a Call
- Rejecting a Call
- Putting a Call on Hold
- About Calling Line Identification (CLI)
- Handling Two Calls

## Useful Information while Talking

- Changing Volume while Talking
- Muting Microphone
- Using Phone as Scratch Pad
- Sending Tone Signals
- Checking Time of Calls

## Navigating the Menu System

- About the Menu System
- Moving Through the Menu System
- Selecting the Key Sound Menu

## Creating Your Own Phone Book

- About the Phone Book
- Storing Numbers on SIM Card
- Storing Numbers in Phone's Memory
- About Recalling Phone Numbers
- Position Recall
- Deleting Storage Position
- About Last Dialed Numbers
- About Unanswered Calls

## Personalizing Your Phone

- Changing Ring Volume
- About Ring Type
- Viewing the Clock
- Setting Clock

- Setting Alarm 14
- Turning Off the Alarm 14
- About Display Language 14
- Changing Key Sound 14

## Making Your Personal Ring Signal

- About the Phone's Note System 15
- Simple Melody 15
- Complex Melody 16

## Diverting Calls

- About Diverting Calls 17
- Diverting 17
- Viewing Status of Call Divert 17
- Cancelling Call Divert 17

## Protecting Your Keypad, Phone and SIM Card

- About Locks 18
- Keypad Lock 18
- Card Lock (SIM) 18
- Changing PIN 18
- Unblocking with PUK 18
- Phone Lock 19
- (Un)Locking Phone 19

## Barring Calls

- Restricting Calls 19
- About Barring Calls 19
- Activating Call Bars for Any Call Type 20
- Cancelling All Call Bars 20

<b>Sending and Receiving Text Messages</b>	<b>21</b>
About Text Messages	21
Checking Subscription	21
Setting Service Center Address	21
Sending SMS	21
About Other Message Types	22
Receiving a Message	22
Reading an Old Message	22
<b>Receiving Area Information</b>	<b>23</b>
About Area Information	23
Activating the Area Information	23
Adding a Code	23
Erasing a Code	23
Changing a Code	23
<b>Knowing Duration of Calls</b>	<b>24</b>
About Duration of Calls	24
Viewing Calling Information	24
<b>Other Networks</b>	<b>24</b>
About Choosing Network	24
Selecting a Network	25
<b>Index</b>	<b>27</b>

# Assembly Instructions

*This chapter describes how you assemble the phone, what the SIM Card is, and how you handle the battery.*

## Assemble and Charge – Four Steps

- Insert the SIM Card.
- Attach the battery.
- Connect the charger to the phone.
- Connect the charger to the mains.

### 1. Inserting SIM Card

Place the SIM Card with the golden connectors facing down and the cut corner turned to the left (see Figure 1).

Slide the SIM Card into the SIM Card slot. The SIM release button will slide towards the antenna as the SIM Card is pushed in.

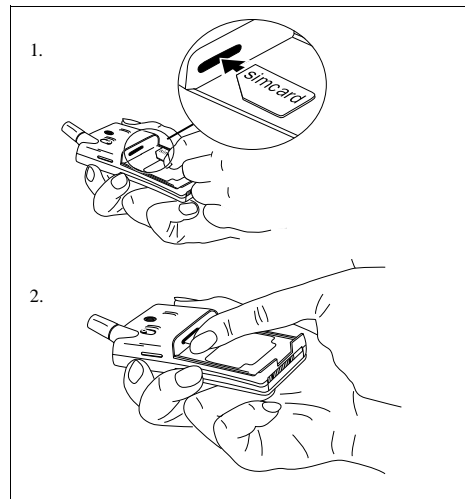

Figure 1. Inserting SIM Card

### Removing SIM Card

1. Make sure the battery is removed.
2. Slide the SIM release button towards you (see Figure 2).
3. Pull out the SIM Card.

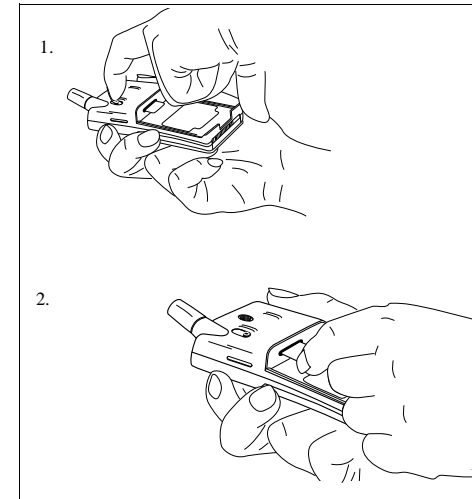

Figure 2. Removing SIM Card.

## 2. Attaching Battery

Place the battery on top of the phone and push until you hear a click (see Figure 3).

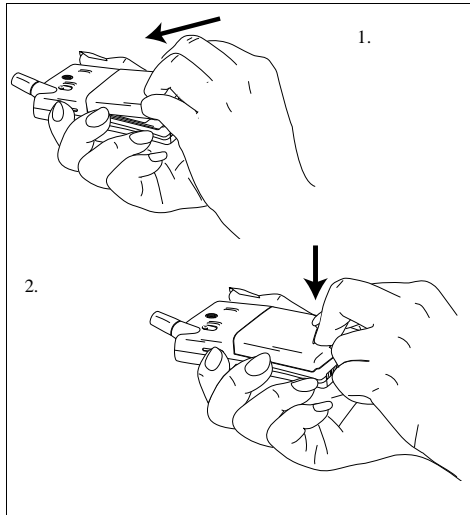

Figure 3. Attaching battery.

## Removing Battery

1. Make sure the phone is turned off.
2. Press the locking catch on the bottom of the battery (see Figure 4.).
3. Lift the battery up and away from the phone.

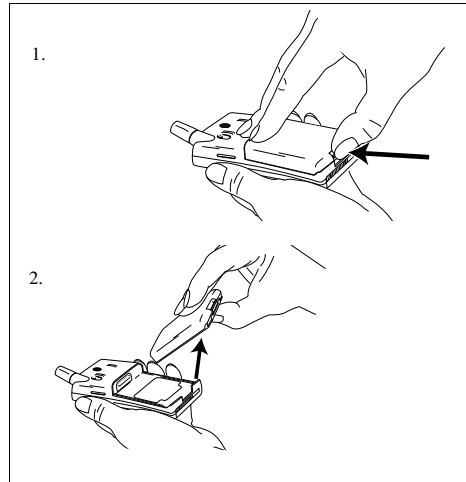

Figure 4. Removing battery.

## 3. Connecting Charger to Phone

Have the battery attached to the phone and connect the charger as described in Figure 5. Use the power plug that fits your mains.

## Disconnecting Charger

Lift the plug up and pull it out (see Figure 5).

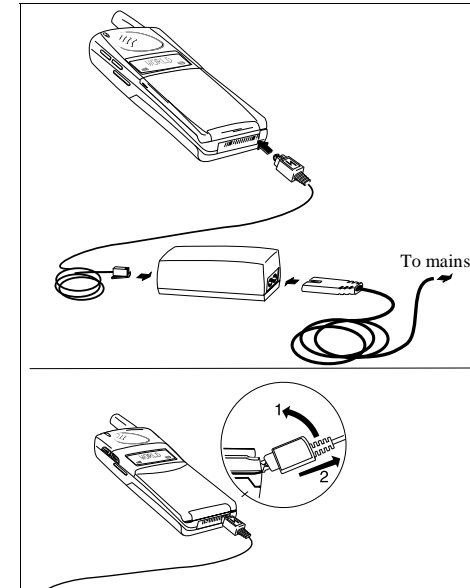

Figure 5. Connecting and disconnecting charger.

## 4. Connecting Charger to Mains

Plug the charger into a mains socket. The phone now starts to charge the battery and you can see the battery meter in the display move while charging.



## About the Charging Function

When you connect external power to the phone, the battery is charged. When the battery is fully charged, the charging stops. You cannot overcharge your battery.

When you are charging the battery you can use your phone as normal; however the charging time will be longer.

## About the Battery and the SIM Card

### The Battery

Your phone is supplied with a Nickel Metal Hydride battery. The battery is not charged before shipment, even though there might be enough power to turn the phone on.

### The SIM Card

Before you can start using your phone, you need to order a SIM Card from a GSM service

provider. The SIM Card is a computer circuit that keeps track of your phone number, the services that you have ordered from the service provider, and your phone book information.

The SIM Card sometimes contains information that lets the phone automatically change the display texts into the language of the SIM Card.

Your SIM Card is supplied with a security code or PIN (Personal Identity Number) that you need to enter into the phone to gain access to the phone and network.

# Turning On the Phone and General Information

*This chapter describes the display information you receive from your phone when you use it.*

## Turning On the Phone

1. Press and hold down the NO key until you hear a click. The display will prompt you to enter the PIN (the security code that follows your SIM Card).

PIN:

2. Enter the PIN and press YES.  
The PIN is indicated as \*\*\*\* in the display.  
If you entered the PIN correctly, you will be welcomed by your phone. Then it searches for a network.

When a network is found, the indicator light on top of the phone flashes green once every second and the standby display is shown (see Figure 6).

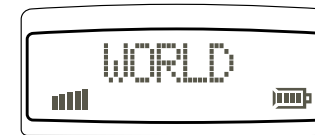

Figure 6. Standby display.

## Turning Off the Phone

- Press and hold the NO key until you hear a click and the display is dark.

## About the Display

Your phone display will help you to:

- Verify that you are dialling correctly.
- Check your battery status.
- Check your signal strength and service availability.
- Indicate that you have received messages.

### Looking at the Display

The picture below shows how the display looks when the entire icon row is lit. Table 1 explains what each icon means.

#### Note!

All icons may not be visible at all times.



Figure 7. Display with all icons lit.

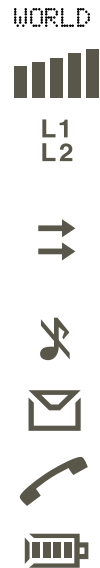

Table 1. Description of display icons.

Icon:	Indicates:
Network	The name and country of the network.
Signal Strength	The received signal strength in five steps, depending on the strength of the signal.
Line	Whether line 1 or 2 is active. The respective icon is lit when the current line is activated. These icons only show if you have two lines on your SIM Card.
Divert	The divert arrow indicates that the phone has a divert active. The arrows corresponds to the line that is diverted.
Silent Ring Signal	Shows that no ring signal will sound when the phone is ringing.
Letter	That you have received a short text message or area information.
Phone	That you are engaged in a call.
Battery	The current battery strength – more bars means more power remaining.

## Learning about Your Phone

The parts list corresponds to Figures 8 and 9:

- 1. Antenna
- 2. Status light
- 3. Earpiece
- 4. Volume keys
- 5. Display
- 6. Keypad
- 7. Microphone (inside)
- 8. Flip
- 9. Microphone channel
- 10. Charging connector
- 11. Battery
- 12. SIM release button
- 13. Phone clip

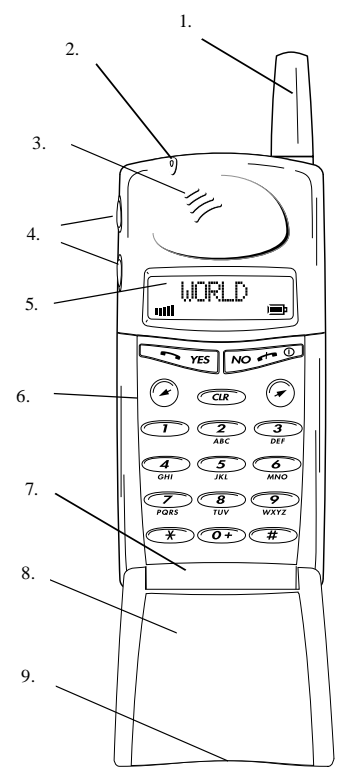

Figure 8. Front view of your phone.

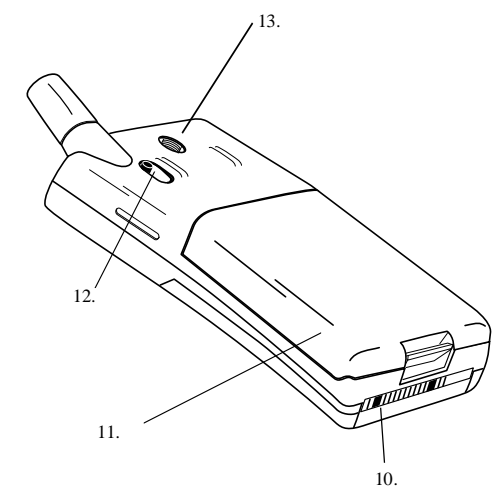

Figure 9. Semi-back view of your phone.

## Making and Receiving Calls

This chapter describes how to make and receive calls, how to make international and emergency calls, how to show or hide your phone number when calling (CLI – Calling Line Identification) and how to handle two calls simultaneously.

### Making a Call

1. Enter the area code and phone number.

The phone number is shown in the display. If the number is longer than 10 digits, the beginning of the number will be shown as an arrow (see Figure 10).

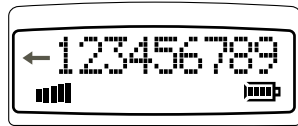

Figure 10. Number with more than 10 digits.

To erase a digit, press **CLR**. To erase the entire phone number, press and hold down **CLR** for a couple of seconds.

2. Press **YES** to make the call. The display shows **Calling**, followed by **Connecting** and the phone icon is lit.

If the number is busy, you will hear a busy tone and the display shows **Busy**.

### Ending a Call

- Press **NO** to end the call.

### Making an International Call

1. Press and hold the zero key until the international + prefix is displayed.
2. Enter the country code, area code (without any leading zero) and the phone number.
3. Press **YES** to make the call.

### Making an Emergency Call

- Enter **112** (The international emergency number) and press **YES**.

The display shows **Emergency**.

The **112** emergency number can be used in any country with or without a SIM Card, provided a GSM network is within range.

### Retry Function

If the call connection fails and the receiver's network admits it, the display shows **Retry?** Press **YES** to redial the number, otherwise **NO**.

If you press **YES**, the number will automatically be redialled until the call is answered, or 10 times at the most. If you press any key, or you receive a call, the redialling is interrupted.

If the redialling is successful, the phone rings twice to inform you.

### Receiving a Call

When you receive a call, the phone rings and the indicator light on the top of the phone blinks green rapidly. The display shows **Answer?**

### Answering a Call

- Press **YES** to answer the call
- When the call is finished, press **NO**.

### Rejecting a Call

- Press **NO** or press a volume key twice when the phone rings.

The display now looks like this:

BusyTone

If the caller's network supports it, the caller will hear a busy tone.

If you have been unable to answer, or you have rejected a call, the number of the unanswered call will be shown in the **Missed Call** menu.

## Putting a Call on Hold

- Press **YES** to put a call on hold. To put the call off hold, press **YES** again.

## About Calling Line Identification (CLI)

The Calling Line Identification service shows the caller's phone number when you receive a call (you have to order this service). If the caller's name is stored in your phone book, the name is displayed instead of the number.

### Showing Your Phone Number

If you subscribe to normally **withhold** your number when calling, you can show the number on a particular call.

1. Enter the number you wish to call.
2. Press **↵**.  
The display shows **Send Id?**
3. Press **YES** to make the call.

### Hiding Your Phone Number

If you subscribe to normally **show** your number when calling, you can hide your number on a particular call.

1. Enter the number you wish to call.
2. Press **↵** twice.  
The display shows **Hide Id?**
3. Press **YES** to make the call.

## Handling Two Calls

Your phone can handle two calls simultaneously. This allows you to hold one call and make or receive another, then you can switch between the two calls.

To be able to receive a second call, you have to activate the Call Wait function.

### Activating the Call Wait Function

- Press **\*43 #** followed by **YES**.

The display will show **Please Wait** followed by **ON**.

### Deactivating the Call Wait Function

- Press **#43 #** followed by **YES**.

### Receiving a Second Call While a Call Is in Progress

When you receive a second call, you will hear a tone in the earpiece and the display shows **Call Wait**.

- Press **YES** answer the second call. The current call is put on hold.  
The display now looks like this.

1 On Hold

- To **reject** the second call, press zero followed by **YES**.

### Switching Between Two Calls

- Press **YES** to switch between the two calls.

### Ending the Current Call and Return to the Held Call

1. Press **NO** to end the current call.  
The display shows **Retrieve?** and you hear two beeps.
2. Press **YES** within three seconds to return to the held call.

If you do not press **YES** within three seconds, the held call is automatically ended.

### **Making a Second Call while a Call Is in Progress**

- Enter the second phone number and press **YES**. The first call is put on hold and the display looks like this:

1 On Hold

### **Receiving a Third Call**

If you are engaged in one call and have a second one on hold, you may receive a third call. You will hear a tone in the ear piece and **CallWait** is shown in the display.

You can only have one call on hold at a time, so you need to end the first or second call before you answer the call.

You can do one of the following:

- Press zero followed by **YES** to reject the third call.
- End the first call, retrieve the held call, and answer the incoming call
- End both calls. The phone rings and the question **Answer?** appears in the display. Press **YES** to answer the call.

## **Useful Information while Talking**

*During a call, you can: change the volume of the ear piece; use the display as a scratch pad; send DTMF tones; check the duration of the current call.*

### **Changing Volume while Talking**

During a call, you can use the volume keys to increase or decrease the ear piece volume (see Figure 11).

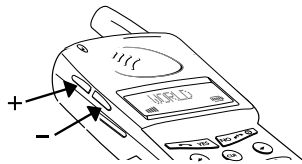

Figure 11. Changing volume.

### **Muting Microphone**

- Press and hold the **CLR** key for as long as you want the microphone muted.

### **Using Phone as Scratch Pad**

1. Enter a phone number on the keypad while talking.  
When you end the call, the number remains in the display.
2. Press **YES** to make the call in the display.

### **Sending Tone Signals**

During a call you can press keys **0 – 9, \* and #** to send DTMF tones. For example, to perform banking by phone or to control an answering machine.

### **Checking Time of Calls**

When you start a call (incoming or outgoing), the airtime is counted in minutes and seconds and shown on the display, like this:

1:34

## Navigating the Menu System

This chapter describes how you navigate through the menu system to get maximum use of your phone.

### About the Menu System

You control the functions of your phone by a menu system.

Some menus have sub-menus that have individual settings. If the menu has sub-menus, three dots appear after the menu name. See the example below:

Barrine...

### Moving Through the Menu System

Use these keys to move through the menu system and to find the different menus.



When you reach the desired menu, press **YES** to choose the menu. Use the / keys until you reach the function or setting you want. Then, in the same way you chose a menu, press **YES** to select the setting or function.

Press this:	To:
<b>YES</b>	confirm a setting or a selection.
<b>NO</b>	reject a setting or a function.
<b>CLR</b>	return to the standby display.
	scroll to the right in the menu system.
	scroll to the left in the menu system.

### Glossary

These terms will be used throughout the manual.

**Scroll:** Pressing the left or right arrow key to move between the menus.

**Select:** Scrolling to a menu and then press **YES**.

**Enter:** Keying in letters or numbers from the keypad.

### Selecting the Key Sound Menu

1. Press **CLR** to clear the display.  
Press the left arrow key until you reach the **Keysound** menu.
2. Press **YES**.  
This is an example to show how to select the **Key Sound** menu.

# Menu Overview

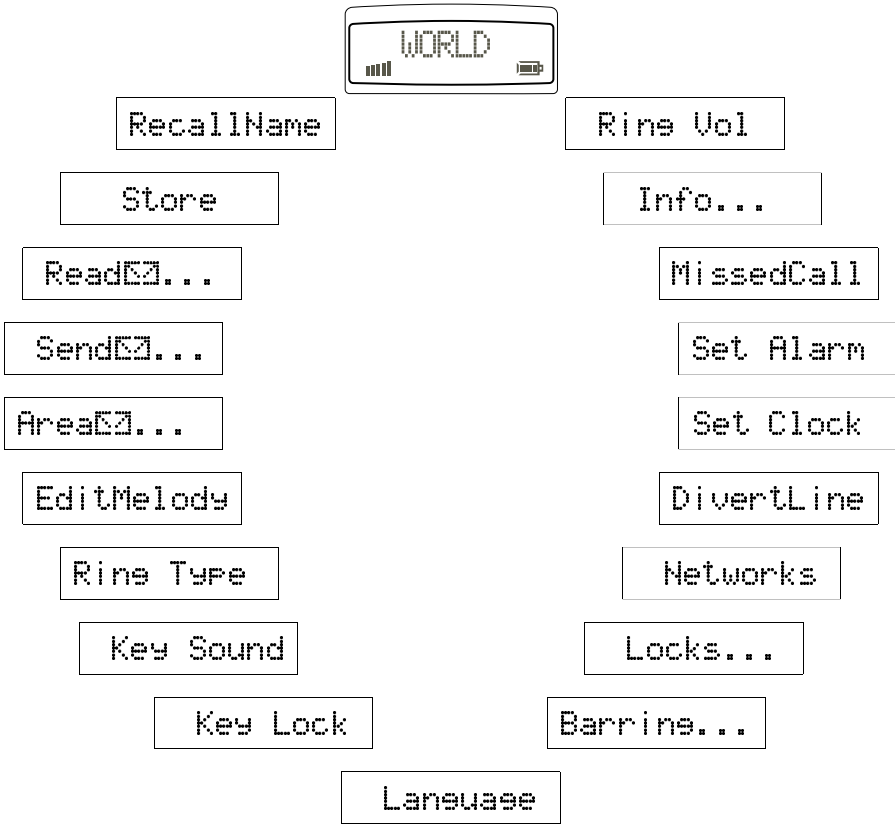



# Creating Your Own Phone Book

This chapter describes how you can store phone numbers both on your SIM Card and in your phone's own memory.

## About the Phone Book

You can store your phone numbers both on your SIM Card and in your phone's own memory. The difference between the two is you can remove the SIM Card and use all those telephone numbers in other phones, while phone's memory always stays the same no matter which SIM Card is inserted.

You can store up to 50 phone numbers in the phone memory. The number of phone numbers you can store on your SIM Card is SIM Card dependent.

### International Numbers

If you intend to use your phone book both at home and abroad, you should store all phone numbers as international phone numbers, i.e. with the international prefix “+” and the country code before the area code (without any leading zero) and the number.

- To enter the plus prefix, press and hold the zero until you see the plus in the display.

### Speed Dialling

The phone numbers that you store in positions 1-9 on the SIM Card can be called by entering the position number and then pressing **YES**. You should, therefore, save positions 1-9 for important numbers.

### Storing Numbers on SIM Card

1. Enter the phone number you wish to store.
2. Press the left arrow key until **Store** is shown and press **YES** twice.
3. Enter the first letter of the name by pressing the appropriate numeric key as many times as required (see Table 2 for all characters). Enter the next letter when the cursor has moved to the next letter position. The number of letters the name can have is SIM Card dependent. Press **YES** when you are done with the name.
4. If you want to store the phone number in the storage position suggested in the display, go directly to step 5.

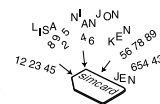

If you want to store the number in a **different position**, press **CLR** to erase the position number displayed and enter another number.

5. Press **YES** to confirm the position number. The display shows **Stored**.

If you have chosen a position number that is already occupied, **Overwrite?** is displayed. Press **YES** to overwrite or **NO** to return to the position number and change it.

### Storing Numbers in Phone's Memory



Follow the the same procedure as storing a phone number on the SIM Card up to step 4. When you are prompted to set storage position number, press **#** once to enter the  $\boxtimes$  character (which indicates storage in phone memory) and twice to have the phone suggesting the first free storage position. Press **YES** to confirm the storage.

## About Recalling Phone Numbers

You can recall a phone number any time from either the SIM Card or the phone memory. You can recall the phone number by either the name or the storage position number.

### Recalling by Name

1. Press **CLR** to erase any digits from the display.
2. Select the **RecallName** menu.  
You are prompted to enter a name.
3. Enter either the full name or the first letter and press **YES**.

The first name that matches the letter string is displayed. If needed, scroll to the name you want.

The selected name and number will blink on the display until you press the \* key.

4. Press **YES** to call the number.

### Recalling by Number – Speed Dialling

1. Press **CLR** to erase any digits from the display.
2. Enter a position number between 1 and 9.
3. Press **YES** to make the call.

## Position Recall

### From SIM Card

1. Enter the position number and press #.
2. Press **YES** to call the number, or scroll until you find the number you want to call and press **YES**.
- Press **CLR** or **NO** to return to the standby display with the number showing.

### From Phone Memory

1. Press and hold # until the ☒ symbol is shown.
2. Enter the position number.

Table 2. List of keypad numbers, symbols and letters.

Press \* to get lower-case letters. Press and hold a key to get the number directly

Press a **volume key** together with a numeric key to get the second or third letter position.

Key	Press the corresponding key this many times to get the symbol.											
	1	2	3	4	5	6	7	8	9	10	11	12
<b>1</b>	space	-	?	!	,	.	:	"	'	(	)	1
<b>2</b>	A	B	C	Å	Ä	Æ	à	Ç	2			
<b>3</b>	D	E	F	è	É	3						
<b>4</b>	G	H	I	ì	4							
<b>5</b>	J	K	L	5								
<b>6</b>	M	N	O	Ñ	Ö	Ø	Ò	6				
<b>7</b>	P	Q	R	S	ß	7						
<b>8</b>	T	U	V	Û	Ü	8						
<b>9</b>	W	X	Y	Z	9							
<b>0</b>	+	&	@	/	\$	%	£	Θ	Ξ	Ψ	Ω	0
<b>#</b>	*	#										

3. Press # to recall number.
4. Press **YES** to call the number, or scroll until you find the number you want to call and press **YES**.

## Deleting Storage Position

1. Select the **RecallName** menu.
2. Choose the name you want to delete, press and hold **CLR**.
3. Press **YES** at the Erase prompt.

## About Last Dialed Numbers

Your phone can store at least the 5 last dialed numbers. The most you can store depends on your SIM Card.

### Recalling From List of Last Dialed Numbers

1. Press **CLR** to erase any digits from the display.

2. Press **YES**. The number last called is shown.
3. Press **YES** to call the number or scroll to the number you want to call.

## About Unanswered Calls

Sometimes you are unable to answer a call. Then the phone keeps track of your latest missed calls in the **MissedCall** menu.

### Checking Unanswered Calls

Select the **MissedCall** menu. A number, a name or Unknown is shown.

Now do one of the following:

- Press **YES** to see who the call is from (CLI).
- Press **CLR** to erase the call.
- Scroll between the entries.

# Personalizing Your Phone

*This chapter describes all the different ways you can personalize your phone to your own requirements.*

## Changing Ring Volume

1. Select the **Ring Vol** menu.
2. Scroll to the desired ring volume, press **YES**.  
Use the volume keys to scroll silently.

### Turning Off Ring Volume

1. Select the **Ring Vol** menu.
2. Press the left arrow key until no squares are lit and press **YES**.  
The standby display now looks like this:



## About Ring Type

You can choose between different types of ring signals. You also have the possibility to choose a melody that you have created yourself. See the chapter on *Making Your Personal Ring Signal*.

### Changing Ring Type

1. Select the **Ring Type** menu.  
The display now looks like this.

Melody 1?

2. Press the right or left arrow to listen to the different ring types. Use the volume keys to scroll silently.
3. Press **YES** to select your preferred ring type.

## Viewing the Clock

If you want to view the time on your phone, press one of the volume keys on the side of the phone.

## Setting Clock

1. Select the **Set Clock** menu.  
The display now looks like this.

14:30

2. Follow the instruction table below on how to set the clock. (Set hours before the minutes.)

To change this:	Do this:
Hours	press the left or right arrow keys.
Minutes	press the number keys.
am or pm	press the * button to toggle.
12-hours or 24-hours	press the # button to toggle.

3. Press **YES** to set the time.

## Setting Alarm

1. Select the **Set Alarm** menu.  
The last alarm time is shown.
2. Enter the alarm time.
3. Press **YES**.

The standby display now looks like this:

World #

Your alarm works even though the phone is turned off.

### When the Alarm Rings...

1. Press any key and the **Turn Off** prompt appears.
2. Press **YES** to turn it off completely or any key to activate the snooze function (9 minutes).

## Turning Off the Alarm

1. Select the **Set Alarm** menu.  
The **Off** prompt appears.
2. Press **YES**.

## About Display Language

Your phone has many languages that you can choose for your display texts. If your SIM card supports the automatic function, the phone has automatically chosen the SIM card default language.

### Note!

When you change language, you change all display texts **immediately**.

### Changing Display Language

1. Select the **Language** menu.
2. Scroll to the language you want is shown and press **YES**.

### Resetting Display Language to English

1. Clear the display.
2. Enter the digit string \*#0000#.

## Changing Key Sound

1. Select the **Key Sound** menu.
2. Select the key sound you want.

## Making Your Personal Ring Signal

This chapter describes how you can make your own ring signal. You will find one example of how to make a simple melody and one example of a little more complex melody. You will also find a table of sample melodies that you can use.

### About the Phone's Note System

Your phone has the capability to handle a range of tones spreading over two octaves.

Look in Table 3 to understand which notes and other notation corresponds to which keys.

Figure 13 also explains which key goes with which note on the keypad.

If you **press and hold** a key, you make the note long.

#### Note!

You do not need to be musical to make your own melody, just look in Table 4 for two sample melodies that are easy to create.

### Simple Melody

The simple melody is *Do-Re-Me*. This song corresponds to the C, D, and E tones on a music scale.



#### Making Do-Re-Me

1. Select the **Edit Melody** menu.  
Your display now looks like this.

\_

2. Press the 1 key.  
The display will now show a **c**.
3. Press the 2 key.  
The display now looks like this:

cd\_

4. Press the 3 key.  
The display now looks like this:

cde\_

5. Press **YES** to test the melody.  
The phone plays the melody and asks you if you want to save the melody.
6. Press **YES** to save the melody as an alternative in the **Ring Type** menu.

Table 3. List of musical notation.

Press this:	To:
1-9	insert notes, where 1 gives a C and 9 a high D.
#	increase or decrease the pitch in half tone steps. Press once to sharp (#), twice to flat (b), three times to get the normal pitch.
*	insert a short pause (1/8).
↶ ↷	scroll within the melody. Press and hold to get to the beginning or end of the melody.
0	get either a higher or a lower octave for the note you have inserted. You know it is higher as a plus sign + is added in front of the note name.
CLR	erase the note to the left of the cursor. If you press and hold CLR, the whole melody is erased.

## Complex Melody

The complex melody is *Twinkle, Twinkle Little Star* — first section. This section corresponds to F, F, C, C, D and C tones on a music scale.

### Making Twinkle, Twinkle Little Star

1. Select the **Edit Melody** menu.  
Your display now looks like this.

---

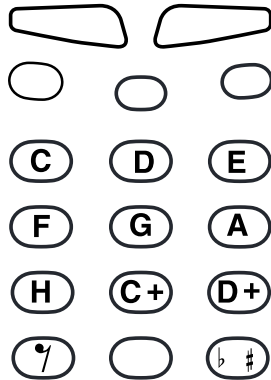

Figure 12. Keypad in musical notes.

2. Press the 4 key twice.  
The display now looks like this:

ff\_

3. Press the 8 key twice.  
The display now looks like this:

ff+c+c\_

4. Press the 9 key twice.  
The display now looks like this:

f+c+c+d+d\_

5. Press and hold the 8 key until you see a capital C with a plus sign in the display.  
The display now looks like this:

c+c+d+d+C\_

6. Press **YES** to test the melody.  
The phone plays the melody and asks you if you want to save the melody.
7. Press **YES** to save the melody as an alternative in the **Ring Type** menu.

Table 4. List of key pressures to make melodies.  
s = short key pressure  
L = long key pressure

Twinkle, Twinkle Little Star.															
Enter:	1s	1s	5s	5s	6s	6s	5s	*	4s	4s	3s	3s	2s	2s	1L
Display:	c	c	g	g	a	a	g	p	f	f	e	e	d	d	C
Fanfare.															
Enter:	5s	5s	5s	*	7s	*	2s	0	*	5L	0				
Display:	g	g	g	p	b	p	+d		p	+G					

## Diverting Calls

This chapter describes the divert function.

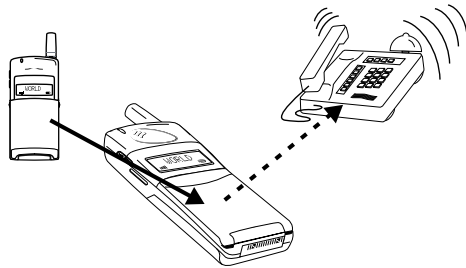

### About Diverting Calls

When supported by your service provider, you can use the **DivertLine** menu to divert (forward) your calls to another number, for example your voice mail or home phone.

#### Note!

If your SIM Card and your service provider support two lines, you need to set each line separately. Here we assume you have one line.

The divert service lets you divert:

- **All calls:** regardless of if your telephone is turned on or off.
- **Unanswered calls:** if you do not answer within 30 seconds, if your phone is busy, turned off or out of reach of a network.

As a reminder, the display will inform you about any activated call divert each time you turn on the phone.

Your standby display now looks like this:

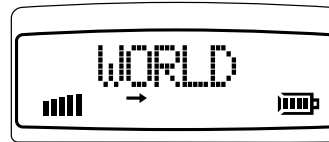

The **DivertLine** menu changes into **DivertOff** when the divert is active.

### Diverting

1. Select the **DivertLine** menu.
2. Select a divert option.
3. Chose **Activate** and press **YES**.

You may now do one of the following:

- Enter a number at the prompt where you want your calls to be diverted, including the area code, and press **YES**.
- Press the left arrow key to enter a name from your phone book and press **YES**.
- Use the phone number that is suggested and press **YES**.

You will only get a number suggested if you have activated the divert function before.

There may be a short delay before the network responds to your divert option, and your display will prompt you when the divert is active (on or off).

### Viewing Status of Call Divert

1. Select the **DivertLine** menu.
2. Select the divert option you wish to view and choose **GetStatus**.

There may be a short delay before the network responds, and your display will prompt you which divert is active (on or off).

### Cancelling Call Divert

1. Select the **DivertLine** menu.
2. Select the divert option you wish to cancel and choose **Cancel**.

There may be a short delay before the network responds, but you will be prompted that your divert is cancelled.

# Protecting Your Keypad, Phone and SIM Card

This chapter describes the different locks that you can use to protect your phone. These are the only ways of protecting your phone in case of theft.

## About Locks

Your phone has three types of locks:

- Keypad lock (does not protect in case of theft)
- Card lock
- Phone lock

The card and phone locks are found in the **Locks** menu and you find the keypad lock in the **Keylock** menu.

## Keypad Lock

You can lock the keypad so that unintentional key action has no effect if the phone is turned on when you are carrying it in a handbag or pocket. When activated, the keypad lock is turned on 30 seconds after the last key action. And the standby display has a lock icon.

The keypad remains locked until you:

- answer or reject a call.
- unlock the keypad yourself.

### Note!

You can always make the international emergency call 112 when the keypad is locked.

## Setting the Keypad Lock

1. Select the **Key Lock** menu.
2. Select **Auto**.

To turn off the automatic keypad lock, select the **Off** option.

## Unlocking Keypad

- Press **▲** and press **YES**.

## Card Lock (SIM)

The card lock protects your SIM Card. When the card lock is active, you will always be prompted to enter your PIN at startup.

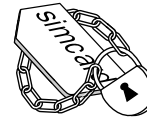

## PINs and PUKs

When you buy your SIM Card, you obtain a 4- to 8-digit PIN (Personal Identity Number) and a longer PUK (Personal Unblocking Key). If your SIM card allows it, you can turn off the card lock.

The PIN is the code that you enter to get access to and activate your subscription. PIN2 is used with special functions.

The PUK (and PUK 2) is a little longer code that helps you unlock your phone when you have forgotten the PIN (PIN2).

## Changing PIN

1. Select **CardLock** in the **Locks** menu.
2. Select **NewPIN**.
3. Enter the old PIN at the prompt and press **YES**.
4. Enter the new PIN and press **YES**.
5. Repeat the new PIN at the prompt and press **YES**.

## Unlocking with PUK

If you have entered the PIN incorrectly three times in a row, the display will read:

PUK:

1. Enter your PUK and press **YES**.
2. Enter a new PIN at the prompt and press **YES**.
3. Repeat the new PIN at the prompt and press **YES**.

If you entered both the PUK and the PIN correctly, the display will read:

New PIN



## Phone Lock

The phone lock protects the phone against unauthorized use of the phone if there is theft. The phone lock is not activated when you buy the phone.



These are the two types of phone locks:

**Autolock:** you need to enter the phone lock code every time you change SIM Card in the phone.

**Full lock:** you need to enter the phone lock code every time you turn on the phone.

### Changing Phone Lock Code

1. Select **Phone Lock** in the **Locks** menu.
2. Select **New Code**.
3. Enter 0000 at the prompt (the factory default code) or your own code and press **YES**.
4. Key in a 4 to 8 digit personal code at the prompt and press **YES**.
5. Repeat the new code at the prompt and press **YES**.

## (Un)Locking Phone

1. Select **Phone Lock** in the **Locks** menu.
2. Select the desired lock option, for example **Auto Lock**.
3. Enter 0000 (the factory default code) or your own phone lock code at the prompt and press **YES**.

To unlock the phone, choose **Unlock** in the **Locks** menu.

## Barring Calls – Restricting Calls

*This chapter describes how you can bar (restrict) calls to and from your phone. This feature is available in your phone, but might not be supported in your subscription.*

### About Barring Calls

The call barring service lets you control which kind of calls can be made to or from your phone. This feature is convenient if you lend your phone to somebody else. This feature is GSM service dependent.

### Barring Options

Your phone supports the following barring options (but your subscription might not support all):

- all outgoing calls – you cannot make any calls.
- all outgoing international calls – you cannot make any international calls.
- all outgoing international calls except to your home country – you cannot make any interna-

tional calls except to the SIM Card home country.

- all incoming calls – you will not receive any calls.
- all incoming calls when you are abroad – you will not receive any calls when abroad.

**Note!**

To activate any of the barring functions, you need a password that comes with your subscription.

## Activating Call Bars for Any Call Type

1. Select either **Incoming** or **Outgoing** call bars from the **Barring** menu
2. Select the barring option you want.
3. Select **Activate**.

4. Enter your password (provided with your subscription) and press **YES**.

There may be a short delay before the network responds and your display will prompt you which call bars have been activated.

Press **CLR** to stop the responses from the network.

## Cancelling All Call Bars

1. Select the **Cancel All** option in the **Barring** menu.

2. Enter your password at the prompt and press **YES**.

There may be a short delay before the network responds and your display will prompt you which call bars have been cancelled.

Press **CLR** to stop the responses from the network.

# Sending and Receiving Text Messages

*This chapter describes SMS, what you need to do before you can send messages, how you send messages, and how you read messages. This service is network dependent.*

## About Text Messages

The Short Message Service (SMS) function allows you to send and receive text messages that contain up to 160 characters. Text messages can be received when the phone is in standby mode, when you are engaged in a call, or when incoming calls are diverted to another phone number. Also, if you have had your phone turned off for a while the network will keep track of the message and send it to your phone as soon as it is turned on.

After a message is received, it is left in the phone's memory, which works similar to a computer's working memory. The message remains in the phone's memory until you read it. You can even turn off the phone and the message will remain intact. If you, on the other hand, change SIM Card, you will lose the unread message. This is because messages should be personal.

### *Note!*

You need to set the service center number before you can **send** any messages. If you only

want to receive messages, you do not need to do anything.

## Checking Subscription

- Call your service provider to see which services your subscription supports, or check the service provider's manual.

## Setting Service Center Address

1. Check the service center address (number) for your service provider.
2. Select **Options** in the **Send** menu.
3. Select **Serv Cent**.
4. Enter the service center address with the international prefix and press **YES**.

## Sending SMS

1. Select **New** in the **Send** menu.
2. Enter your message and press **YES**. You can also enter a phone number.

See Table 2 for all letters and symbols available.

3. Enter the phone number, or press the left arrow key to enter a name you want to send to and press **YES**.

The display now looks like this:

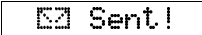

If your message does not go through, it will be sent back to you.

## Setting Duration of Message

1. Select **Options** in the **Send** menu.
2. Select **Valid Per**.
3. Select how long you want the message to be repeated.  
The service center repeats the message for the set duration or until the receiver can receive it.

## About Other Message Types

You can send SMS from your phone to the service center and the service center can change

the message into the following types (if supported):

**E-Mail**

The E-mail address cannot contain more than 20 characters.

**Telex**

**Fax**

Both group 3 and 4.

**X400**

**Voice**

**Changing Message Type**

1. Select **Options** in the **Send** menu.
2. Select **Msg Type**.
3. Select the message type you want.

**Receiving a Message**

When you receive a message the display looks like this:

At the same time you will hear a beep as loud as the ring signal and the green light on top of the phone will flash.

**Reading an Incoming Message**

1. Press **YES** when you have received a message.



The display will show you the date of the incoming SMS, you can see the time by pressing \*.

2. Press **YES**.

The display will show you from which phone number the message is sent, or the name if stored in your phone book. The display could now look like this:

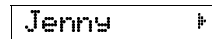

The arrow shows you that you can start scrolling through the message with the right arrow key.

3. Press the right arrow key to read the message.

When you have read a message, you can do one of the following:

- **Call** a phone number in the message by pressing **YES**.
- **Erase** the message by pressing **YES** at the erase prompt.
- **Store** the message by pressing **NO** at the erase prompt (you may get a reply prompt if the sender has required a reply). Press **YES** at the **Store** prompt and the message is stored on the SIM Card.

**Erasing a Message**

- Press **CLR** any time during the message and answer **YES** on the question prompt.

**Reading an Old Message**

1. Select the **Read** menu.
2. Scroll to the message you want to read and press **YES**.
3. Read through the message by pressing the right arrow key.

## Receiving Area Information

*This chapter describes how you can make your phone available for Area Information (AI). This service is network dependent.*

### About Area Information

While the SMS function is a personal service with messages directed to you, the Area Information is a broadcast type message that is sent to all subscribers in a certain cell, for example a section of a city, at the same time. You can set your phone to receive only those types of messages you want to listen to, e.g.: the local weather forecast or the local traffic report. Each message is identified by a 3-digit code. Check with your service provider for which message types are available in your network. When you receive an AI the display looks like this:

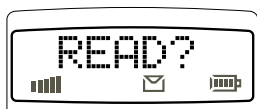

The default setting for the phone is that the AI service is turned off.

At present the following message types exist:

Code	Title
000	Index
010	Flashes
020	Hospitals
022	Doctors
024	Pharmacy
030	Long-distance road reports
032	Local road reports
034	Taxis
040	Weather
050	District
052	Network information
054	Operator services
056	Directory enquiries (national)
057	Directory enquiries (international)
058	Customer care (national)
059	Customer care (international)

### Activating the Area Information

- Select **On** in the **AreaInfo** sub-menu.

### Adding a Code

1. Select **EditList** in the **AreaInfo** sub-menu.
2. Press the right arrow key to find the first empty position and press **YES**.
3. Enter a new code and press **YES**.  
The display could now look like this if you have added the pharmacy title to the second position:

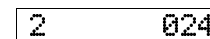

### Erasing a Code

1. Select **Edit List** in the **AreaInfo** sub-menu.
2. Scroll to the position (to the left in the display) you wish to erase and press **YES**.
3. Press **YES** at the erase prompt.

### Changing a Code

1. Select **Edit List** in the **AreaInfo** sub-menu.
2. Scroll to the position (to the left in the display) you wish to change and press **YES**.
3. Scroll to **New Code** and press **YES**.
4. Enter the new code and press **YES**.

## Knowing Duration of Calls

*This chapter describes how you can keep track of the duration of your calls.*

### About Duration of Calls

Your phone is capable of keeping track of the following:

#### Total Calls:

This feature shows the total time of all calls in hours and minutes since the meter was last set.

#### Outgoing Calls:

This feature tracks the time of all your outgoing calls in hours and minutes since the meter was last set.



#### Last Call:

This feature tracks the duration of your last call in minutes and seconds.

The duration of the call appears in the display after a call is finished. The total time of all calls is recorded in the phone and is also default.

### Viewing Calling Information

There are two ways to view the calling information:

- Look in the display for the duration or cost of your last call when it is ended.
- Select the **Info** menu to view all options.

## Other Networks

*This chapter describes how you select a different network when you are out of range of your home service provider's network.*

### About Choosing Network

When you turn on the phone, it selects its home network. If this is not within range, you might not be able to get any reception or, if you are abroad, you can choose a different network,

provided your service provider has an agreement allowing you to use the network. This is called roaming.

When you select the Networks menu, the phone automatically searches for all networks present in the area you are in. Each network that is

found, has a status indication telling you whether the network is available or forbidden.

See the list below for a description of the status indication:

<b>Display:</b>	<b>Meaning:</b>
Network and #	home network
Network and *	currently used network
Network and A	other available networks
Network and S	other available network (given priority by your home service provider)
Network and F	forbidden networks
Auto	automatic network search

**Note!**

The status of forbidden networks can change, so it is important that you make a network search to update the list, especially when you are visiting another country.

Auto is the basic setting for the network search and selection. This setting means that your phone takes care of all the network search and selection.

### Selecting a Network

1. Select the **Networks** menu.

The phone performs a network search and the display shows the current network followed by the network list.

2. Scroll through the network list to see which networks are available.

3. Press **YES** to select a network.

When you have made a network selection, **Networks?** is shown whenever the phone cannot contact the desired network. You can now either:

- Select a new network.
- Set the phone to the automatic search mode.

### Setting Phone to Automatic Network Search

1. Select the **Networks** menu.
2. Scroll, after the search, to **Auto** and press **YES**.





# Index

## A

AI	
See Area information	
Alarm	
setting	14
snooze	14
turning off	14
Answering calls	6
Antenna	5
Area information	23
about	23
activating	23
adding codes	23
changing codes	23
erasing codes	23
Assembly	1
Assembly instructions	1
Autolock	19

## B

Barring calls	
about	19
activating	20
cancelling	20
Battery	5
about	3
attaching	2
removing	2
status	4
Battery icon	4
Busy tone	6

LZT 126 1343/2 R1A

## C

Call wait	7
Calling line identification	7
Calls	
answering	6
barring	19
diverting, about	17
duration	24
emergency	6
ending	6
hold	7
international	6
making	6
outgoing	24
price	24
receiving	6
rejecting	6
restricting	19
total	24
Charger	
connecting	2
connector	5
disconnecting	2
function	3
CLI	7, 13
Clock	
setting	14
viewing	14
Complex melody	16

## D

Dialling	4
Display	5
information	4
language	14
Divert icon	4
Diverting calls	17
about	17
cancelling	17
extended menu	17
reduced menu	17
view status	17
Duration of calls	24

## E

E-mail	22
Earpiece	5
Emergency calls	6
Enter	9
Erasing text message	22

## F

Fax	22
Flip	5
Full lock	19

## G

General information	3
Glossary	9

---

**I**

International numbers	
storing	11
International prefix	6

---

**K**

Key sound	
changing	14
Keypad	5
lock	18
unlock	18
Keypad lock	
turning off	18

---

**L**

Language	
display, changing	14
Language reset	14
Last dialled	
about	13
numbers recall	13
Letter icon	4
Line indicator icon	4
Locks	
about	18
keypad	18
phone	19
SIM	18

---

**M**

Mains	2
Making	
ring signal	15
Making calls	6
Melody	
complex	16
simple	15
Memory	
phone	11
SIM	11
Menu system	
about	9
overview	10
Message type	
changing	22
Message types	
e-mail	22
fax	22
telex	22
voice	22
X400	22
Messages	
See Text messages	
Microphone	5
mute	8
Microphone channel	5

---

**N**

Network	
selecting	25
Nickel metal hydride	3
Noting music	15

---

**O**

Overview	
menus	10

---

**P**

Phone	
locking	19
locking code	19
turning off	3
unlocking	19
Phone book	11
about	11
changing	12
Phone clip	5
Phone icon	4
Phone number	
hiding	7
showing	7
storing	11
PIN	
about	18
changing	18
Position recall	
from phone	12
from SIM	12
Protecting phone	18
PUK	18
about	18

**R**

Recalling  
 by name 12  
 by number 12  
 Receiving calls 6  
 Rejecting calls 6  
 Ring signal 15  
 icon 4  
 personal 15  
 See Ring volume  
 Ring type  
 about 13  
 changing 13  
 Ring volume  
 changing 13  
 muting 13  
 Ringing alarm 14  
 Roaming 24

**S**

Scroll 9  
 Select 9  
 Service center 21

setting 21  
 Setting keypad lock 18  
 Signal strength icon 4  
 SIM Card  
 about 3  
 inserting 1  
 protecting 18  
 release button 1, 5  
 removing 1  
 Simple melody 15  
 SMS  
 See Text messages  
 Snooze 14  
 Speed dialling 12  
 Stopping calls  
 See Barring calls  
 Storing numbers  
 Phone memory 11  
 SIM Card 11

**T**

Telex 22  
 Text message  
 about 21

erasing 22  
 going through 21  
 reading 22  
 saving 22  
 sending 21  
 types 22  
 Turning off phone 3  
 Turning on phone 3  
 Two calls 7

**U**

Unanswered calls 13  
 Unblocking 18

**V**

Voice (message) 22  
 Volume keys 5

**X**

X400 22